

Drilling position measurement

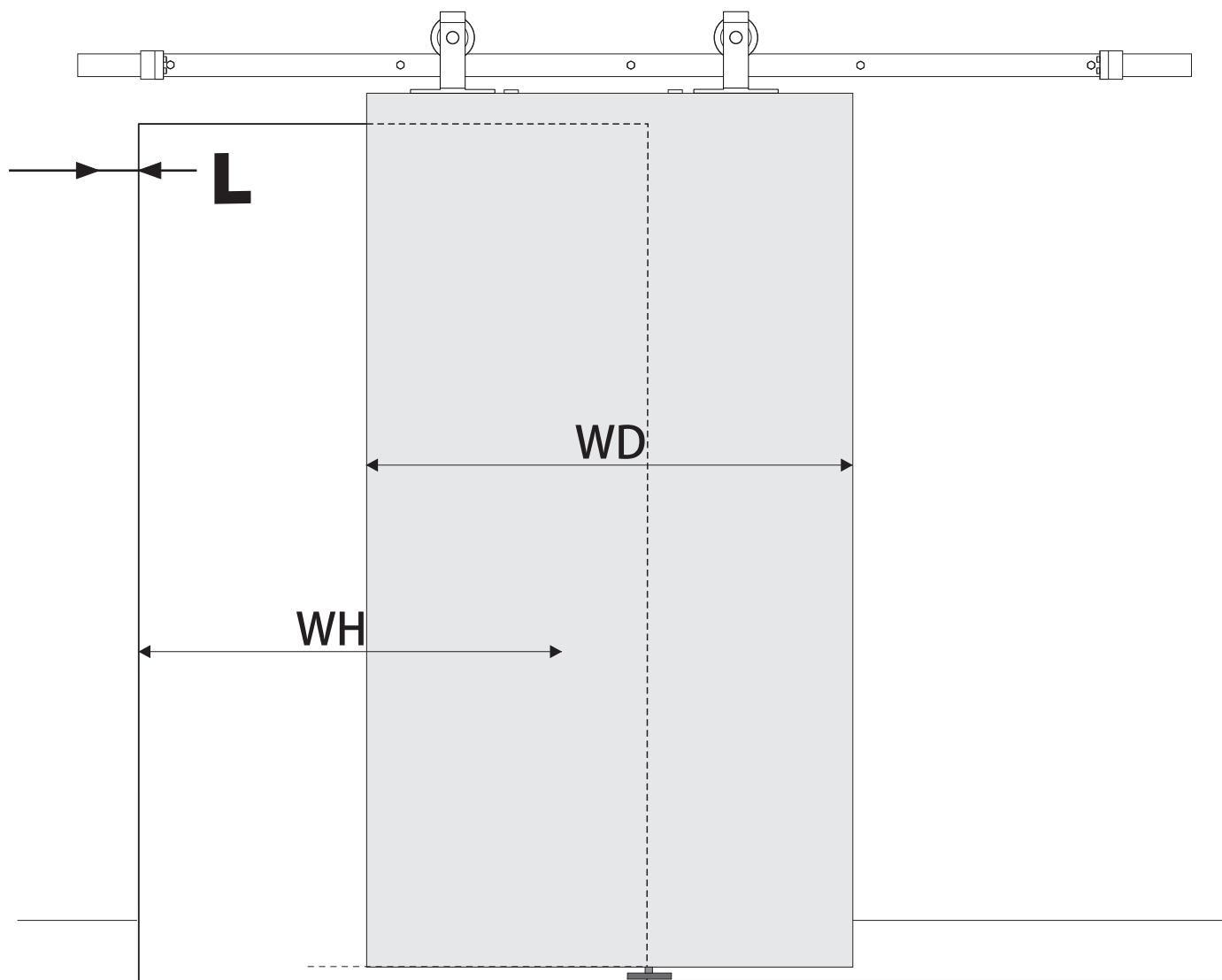

D(mm)	L(mm)
70	$45 + (WD - WH) / 2$
100	$80 + (WD - WH) / 2$
150	$40 + (WD - WH) / 2$

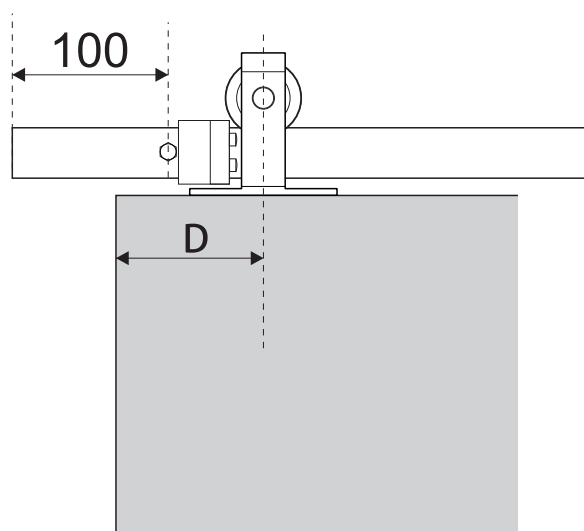

Installation Manual

